

SU Series: DIN Rail Snap-Mount Sockets



SU2S-11L

Style	8-blade DIN-mount/surface mount
Terminal	Spring clamp terminals
Wire Size	24-16 AWG
Electrical Rating	10A
Compatible Relay	RU2, RM2
Compatible Timer	GT5Y-2
Hold-Down Clip	SFA-101 (top latch), SFA-202 (side latch)

SU4S-11L

Style	14-blade DIN-mount/surface mount
Terminal	Spring clamp terminals
Wire Size	24-16 AWG
Electrical Rating	6A (using RU4), 10A (using RU2)
Compatible Relay	RY4S, RY42S, RU4, RU42S, RY2KS, RM2S
Compatible Timer	GT5Y
Hold-Down Clip	SFA-101 (top latch), SFA-202 (side latch)

1. On the SU2S, wires or ferrules cannot be connected to terminals 2, 3, 6, 7, 10 or 11 because neither springs nor conductive brackets are installed in these terminals.
2. For socket mounting accessories, see page F-29.

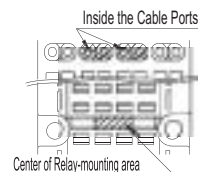

Sockets

Terminal Arrangement (top view)

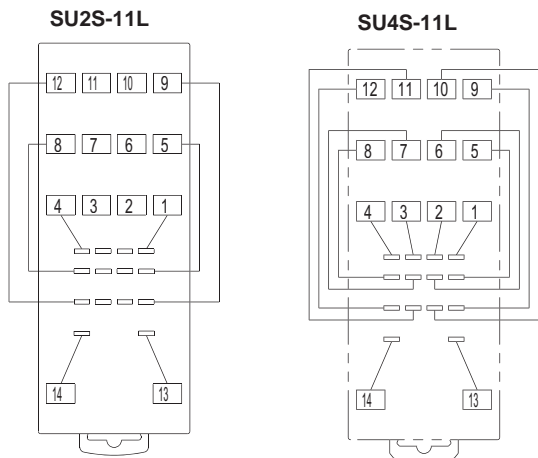

Dimensions

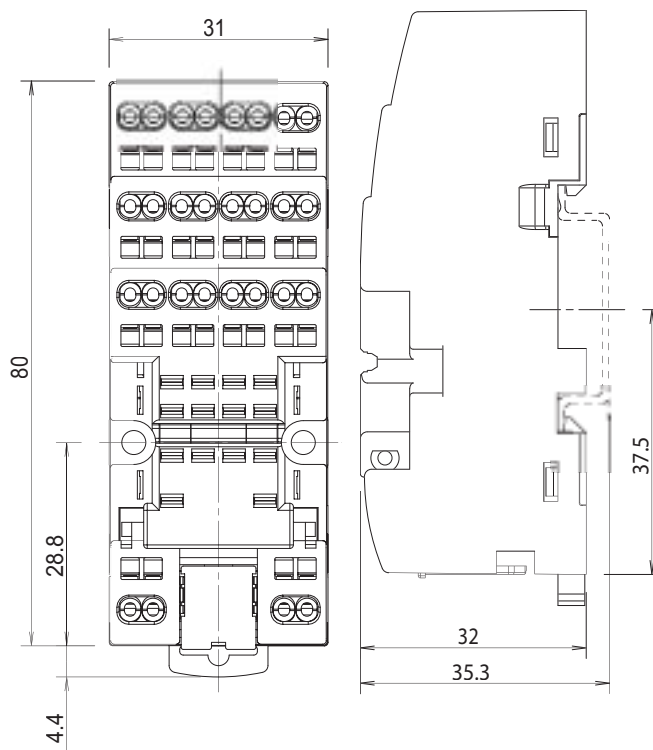

Parts

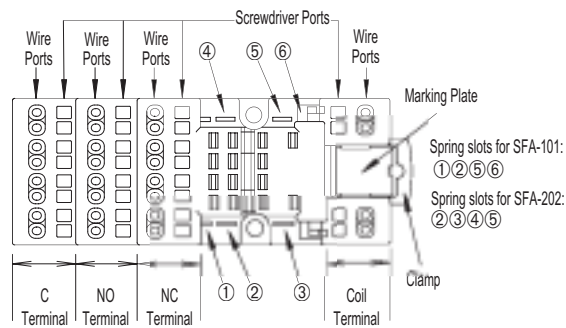

Panel Cutout for Surface Mounting

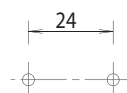

All dimensions are in mm.

SU Series: General Instructions

Applicable Wires

Wire	Size
Stranded wire	0.2 to 1.25 mm ² or AWG24 to 16
Solid wire	0.2 to 1.5 mm ² or AWG24 to 16
Wire insulation diameter	ø3.15mm maximum



- Strip the wire insulation 9 to 10mm from the end.
- In applications using ferrules for stranded wires, choose the ferrule listed in table below. Make sure that an insulation sheath is applied when using the ferrules. When using stranded wires without ferrules, make sure that the core wires have not been loosened.
- Two cable ports are provided for each terminal.

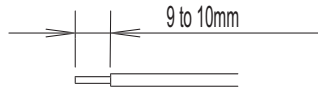

Applicable Ferrules

Applicable Wire (stranded)		Type	Manufacturer
mm ²	AWG		
0.2	24	A10.25-12BU	Phoenix Contact
-	22	A10.34-8TQ	Phoenix Contact
0.5	20	A10.5-8WH	Phoenix Contact
		A10.5-10WH	
		TE0.5	Nichifu Co. Ltd

For wiring, use the optional screwdriver (BC1S-SDO) or the following applicable screwdriver.

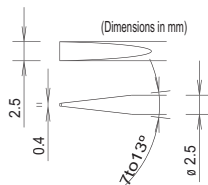

Marking Instructions

Write markings on the SU sockets using an oil-based marker, or glue printed mylar on the marking surface. The size of the printed mylar can be 8 x 9mm maximum.

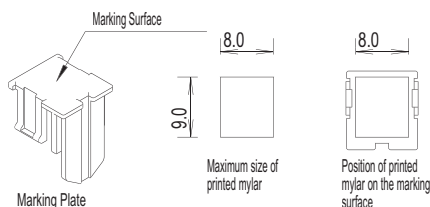

Wiring Instructions

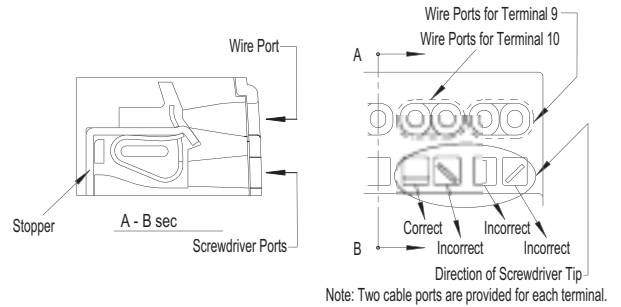

1. Insert the optional screwdriver (BC1S-SDO) or an applicable screwdriver into the square-shaped port as shown on the right, until the screwdriver tip touches the bottom of the spring.

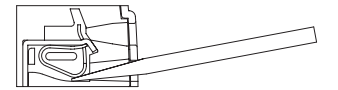

2. Push in the screwdriver until it touches the bottom of the port. The wire port is now open, and the screwdriver is held in place. The screwdriver will not come off even if you release your hand.

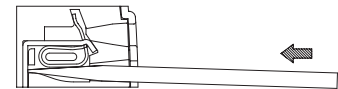

3. While the screwdriver is retained in the port, insert the wire or ferrule into the round-shaped wire port. Each wire port can accommodate one wire or ferrule. When connecting two wires to one terminal, use the adjoining port of the same terminal.

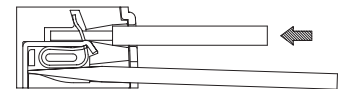

4. Pull out the screwdriver. The connection is now complete.

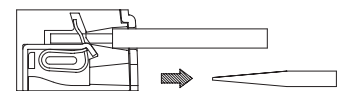

Safety Precautions

Installing the Marking Plate

Because of its removable structure, the marking plate may have fallen from the socket or become loose in delivery. Make sure that the marking plate is securely installed before starting operation. The marking plate protects the conductive portion of the socket, located under the marking plate, by preventing metal fragments or pieces of wire from dropping inside. Should any such fragments enter the socket, they may cause fire hazard, damage, or malfunction.

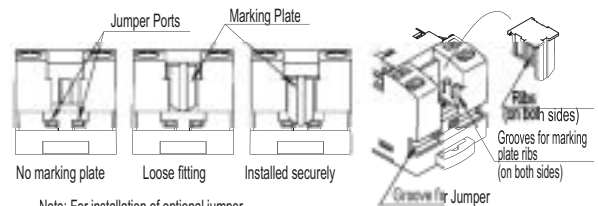

Note: For installation of optional jumper, see the instruction sheet provided with the jumper.

Inserting Screwdriver into the Wire Ports

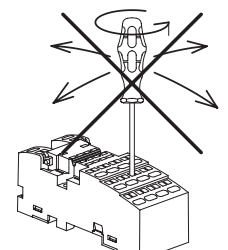

SU Series: SU9Z-J5 Jumper Installation Instructions

SU9Z-J5 Jumper for SU2S-11L and SU4S-11L

The SU9Z-J5 is used to install five sockets. When installing less than five sockets cut the jumper according to the instructions listed to the right.

The SU9Z-J5 jumper is for coil terminals only.

SU9Z-95 Jumper		
Rated Current	3A	
Material	Conductor	Nickel-plated brass
	Sheath	ABS resin

Installation

Loosen the marking plate on the socket.

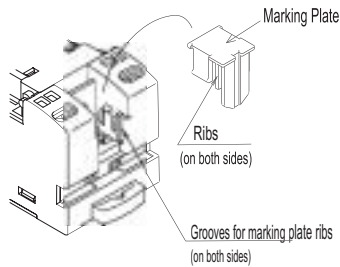
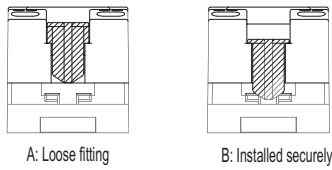

Alignment

Making sure that the SU9Z-J5 jumper is correctly aligned, insert the blades into the ports in the groove of the SU sockets.

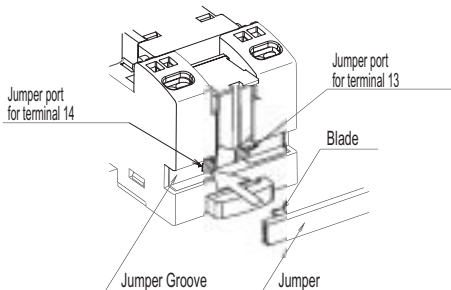
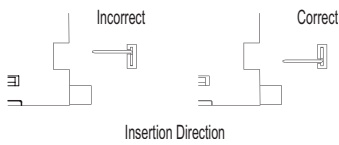

Install Jumper Securely

Press down the marking plate to secure the jumper. The jumper installation is now complete.

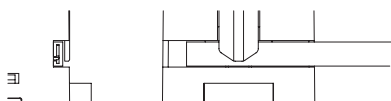

Installing Two, Three or Four SU Sockets on the SU9Z-J5 Jumper

As shown below, slide the jumper in the sheath so that the jumper aligns with the center of the sheath.



With the sheath properly installed on the jumper, cut the sheath and jumper at the points shown below, using cutting pliers. Referring to the drawing on the right, make sure that the sheath and jumper are cut within the cutting area. Dispose of unused portions according to local waste disposal requirements.

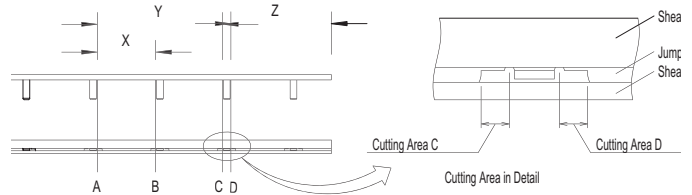

	Qty	Cutting Area	Discard
2 Sockets	2	A, C	Y
2 Sockets	1	A, B	X
3 Sockets			
4 Sockets	1	D	Z

After cutting the jumper and sheath, slide the jumper as shown below, so that the ends of the jumper are not exposed.



Jumper Wiring to Six or More SU Sockets

To jumper wire six or more SU sockets, connect five sockets using whole jumpers and the remaining sockets using a cut jumper. Then connect the two terminals on adjoining sockets using an applicable wire (see table below).

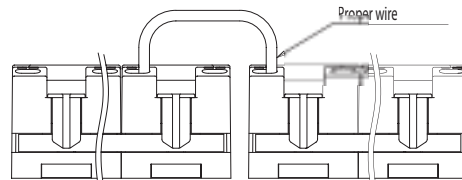

Wire	Size
Stranded wire	0.2 to 1.25 mm ²
Solid wire	0.2 to 1.5 mm ²
AWG	24 to 16



1. Use a wire with cable insulation diameter of $\phi 3.15\text{mm}$ maximum.
2. Strip the cable insulation 9 to 10mm from the end.

Safety Precautions

Turn off the power to the SU9Z-J5 jumper before starting installation, removal, wiring, maintenance, or inspection of the jumper. Failure to turn power off may cause an electrical shock or fire hazard.

To avoid a short circuit due to incorrect wiring, confirm which terminals are connected to the jumper before beginning wiring.

SJ Series: General Information



SJ1S-05B

Style	5-blade snap mount/surface mount
Terminal/Torque	0.6 - 1.0N•m (Maximum 1.2N•m)
Wire Size	Maximum up to 2 - #14 AWG
Electrical Rating	250V, 12A
Compatible Relay	RJ1S
Compatible Timer	N/A
Hold-Down Spring	N/A
Replacement Locking Lever	SJ9Z-C

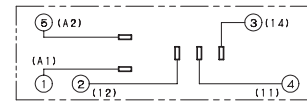
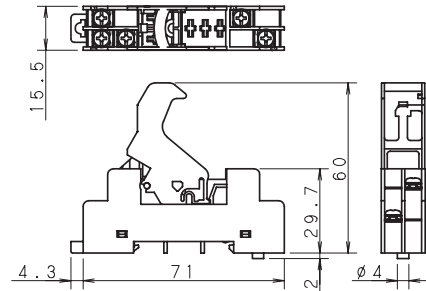

(Top View)



SJ1S-07L Fingersafe

Style	5-blade, snap mount/surface mount
Terminal/Torque	0.6 - 1.0N•m (Maximum 1.2N•m)
Wire Size	Maximum up to 2 - #14 AWG
Electrical Rating	250V, 12A
Compatible Relay	RJ1S
Compatible Timer	N/A
Hold-Down Spring	N/A
Replacement Locking Lever	SJ9Z-C

SJ1S-07L

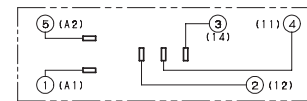
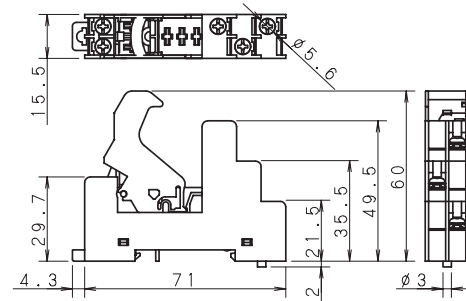

(Top View)



SJ2S-05B

Style	8-blade, snap mount/surface mount
Terminal/Torque	0.6 - 1.0N•m (Maximum 1.2N•m)
Wire Size	Maximum up to 2 - #14 AWG
Electrical Rating	250V, 8A
Compatible Relay	RJ2S
Compatible Timer	N/A
Hold-Down Spring	N/A
Replacement Locking Lever	SJ9Z-C

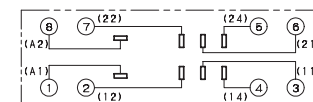
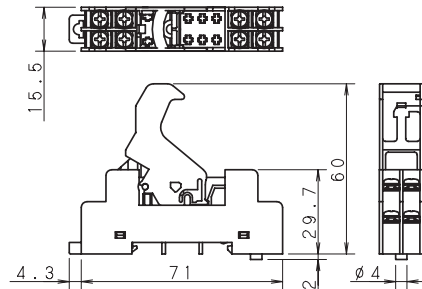

(Top View)

All dimensions are in mm.



SJ2S-07L Fingersafe

Style	8-blade snap mount/surface mount
Terminal/Torque	0.6 - 1.0N•m (Maximum 1.2N•m)
Wire Size	Maximum up to 2 - #14 AWG
Electrical Rating	250V, 8A
Compatible Relay	RJ2S
Compatible Timer	N/A
Hold-Down Spring	N/A
Replacement Locking Lever	SJ9Z-C

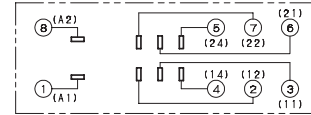
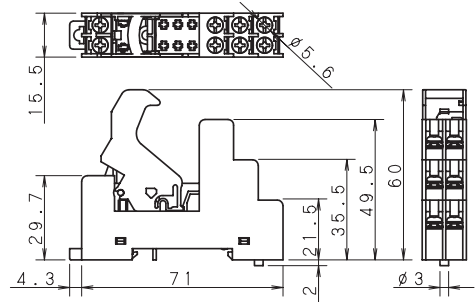

(Top View)

All dimensions are in mm.

F

SQ Series: General Information

Sockets



SQ1V-07B Fingersafe

Style	5-pin, snap mount/surface mount
Terminal/Torque	1.0N•m Maximum
Wire Size	Maximum up to 2 - #14 AWG
Electrical Rating	300V, 12A
Compatible Relay	RQ1V-CM
Replacement Locking Lever	SQ9Z-C
Replacement Marking Plate	SQ9Z-P
Plug-in LED/Diode (6-24VDC)	SQ9Z-LD
Plug-in LED/RC (120/240VAC)	SQ9Z-LR

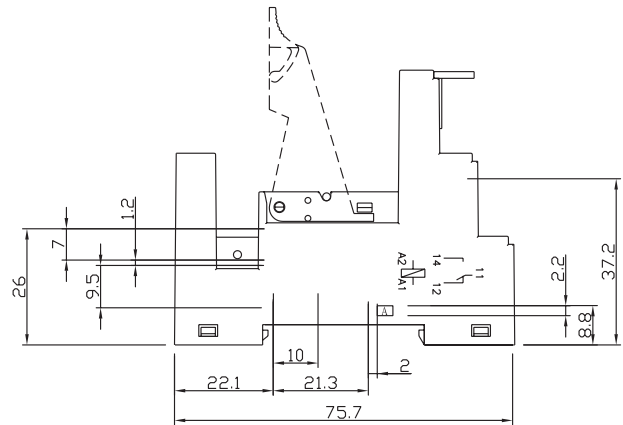

SQ2V-07B Fingersafe

Style	8-pin, snap mount/surface mount
Terminal/Torque	1.0N•m Maximum
Wire Size	Maximum up to 2 - #14 AWG
Electrical Rating	300V, 8A
Compatible Relay	RQ2V, RQ1V-CH
Replacement Locking Lever	SQ9Z-C
Replacement Marking Plate	SQ9Z-P
Plug-in LED/Diode (6-24VDC)	SQ9Z-LD
Plug-in LED/RC (120/240VAC)	SQ9Z-LR

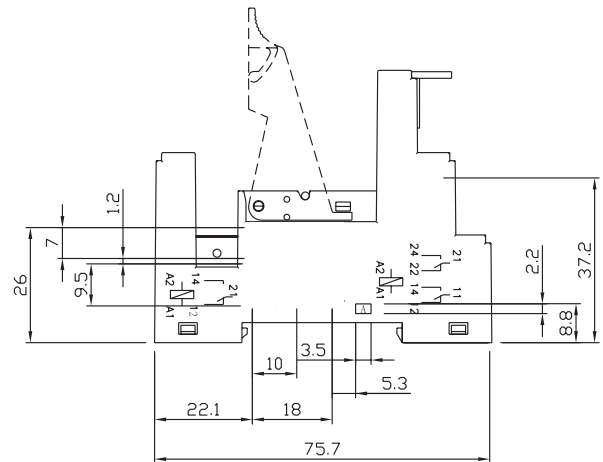

All dimensions are in mm.

SR Series: DIN Rail Snap-Mount Sockets

SR2P Sockets



SR2P-05

Style	8-pin octal, snap-mount/surface mount
Terminal/Torque	M3.5 screws with captive wire clamp (9 - 11.5 in•lbs)
Wire Size	Maximum up to 2-#12AWG
Electrical Rating	300V, 10A
Compatible Relay	RR2P
Compatible Timer	RTE-P1, GT3 (8-pin), GT5P, GE1A
Hold-Down Spring	SR2B-02F1 (for RR2P)
Hold-Down Clip	SFA-203 (for timers only, except GE1A)

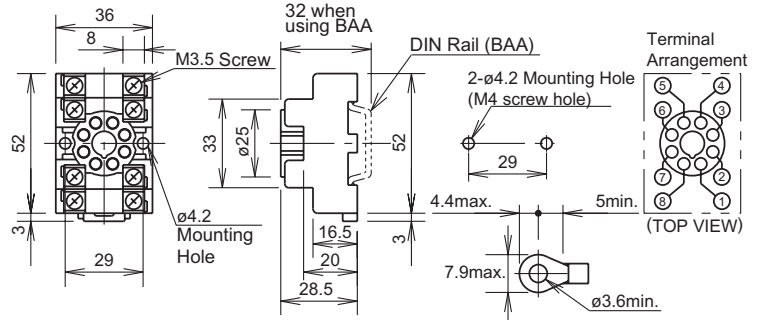

SR2P-05C Fingersafe

Style	8-pin octal, snap-mount/surface mount
Terminal/Torque	M3.5 screws with captive wire clamp, fingersafe (9 - 11.5 in•lbs)
Wire Size	Maximum up to 2-#12AWG
Electrical Rating	300V, 10A
Compatible Relay	RR2P
Compatible Timer	RTE-P1, GT3 (8-pin), GT5P, GE1A
Hold-Down Spring	SR2B-02F1 (for RR2P)
Hold-Down Clip	SFA-203 (for timers only, except GE1A)

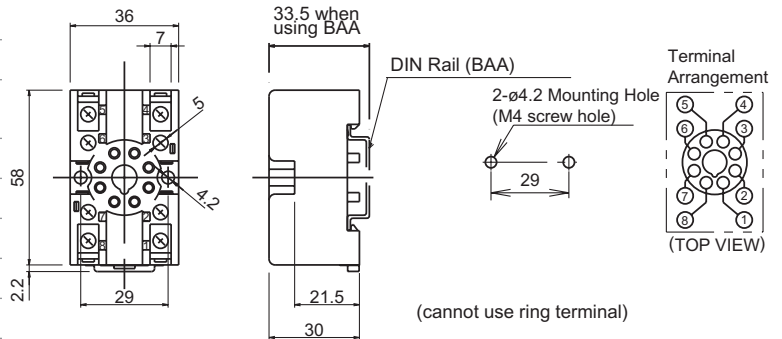

SR2P-06

Style	8-pin octal, snap-mount/surface mount
Terminal/Torque	M3.5 screws with captive wire clamp (9 - 11.5 in•lbs)
Wire Size	Maximum up to 2-#12AWG
Electrical Rating	300V, 10A
Compatible Relay	RR2P
Compatible Timer	RTE-P1, GT3 (8-pin), GT5P, GE1A
Hold-Down Spring	SR2B-02F1 (for RR2P)
Hold-Down Clip	SFA-202 (for timers only, except GE1A)

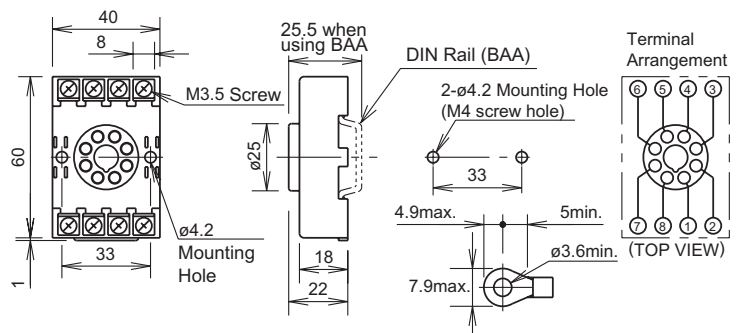

1. For socket mounting accessories, see page F-29.
2. For hold-down clip/spring selections, see page F-4.

All dimensions are in mm.

SR3P Sockets



SR3P-05

Style	11-pin octal, snap-mount/surface mount
Terminal/Torque	M3.5 screws with captive wire clamp (9 - 11.5 in•lbs)
Wire Size	Maximum up to 2-#12AWG
Electrical Rating	300V, 10A
Compatible Relay	RR3PA, RR2KP
Compatible Timer	GT3 (11-pin), RTE-P2
Hold-Down Spring	SR3B-02F1 for RR3P; SR3P-06F3 for RR2KP
Hold-Down Clip	SFA-203 (Timers)

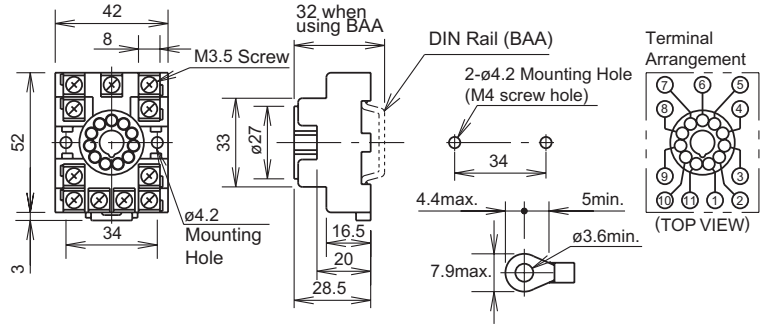

Sockets



SR3P-05C Fingersafe

Style	11-pin octal, snap-mount/surface mount
Terminal/Torque	M3.5 screws with captive wire clamp, fingersafe (9 - 11.5 in•lbs)
Wire Size	Maximum up to 2-#12AWG
Electrical Rating	300V, 10A
Compatible Relay	RR3PA, *RR2KP (*latching relay)
Compatible Timer	GT3 (11-pin), RTE-P2
Hold-Down Spring	SR3B-02F1 for RR3PA; SR3P-06F3 for RR2KP
Hold-Down Clip	SFA-203 (Timers)

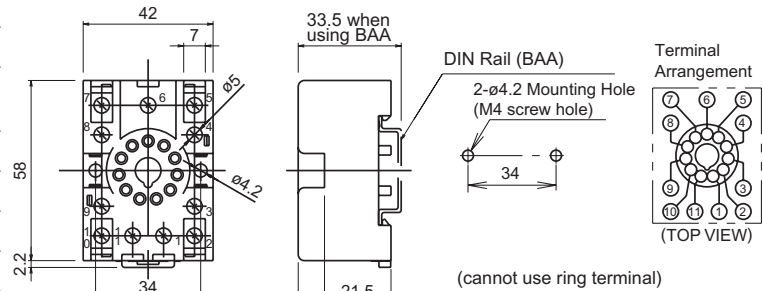

SR3P-06

Style	11-pin octal, snap-mount/surface mount
Terminal/Torque	M3.5 screws with captive wire clamp (9 - 11.5 in•lbs)
Wire Size	Maximum up to 2-#12AWG
Electrical Rating	300V, 10A
Compatible Relay	RR3PA, *RR2KP (*latching relay)
Compatible Timer	GT3 (11-pin), RTE-P2
Hold-Down Spring	SR3B-02F1 for RR3PA; SR3P-06F3 for RR2KP
Hold-Down Clip	SFA-202 (Timers)

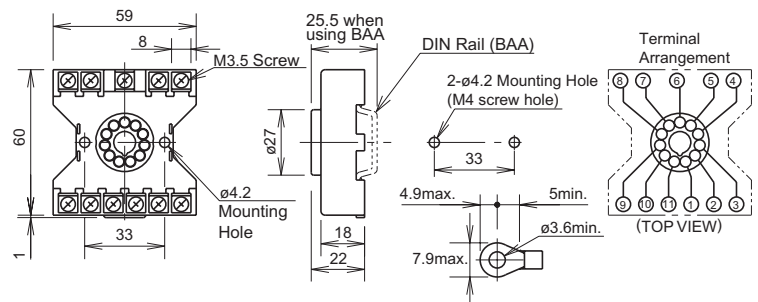

1. For socket mounting accessories, see page F-29.
2. For hold-down clip/spring selections, see page F-4.

All dimensions are in mm.

SR3B Sockets



SR3B-05

Style	11-blade, snap-mount/surface mount
Terminal/Torque	M3.5 screws with captive wire clamp (9 - 11.5 in•lbs)
Wire Size	Maximum up to 2-#12AWG
Electrical Rating	300V, 15A (10A)* (*denotes CSA rating)
Compatible Relay	RR1BA, RR2BA, RR3B
Compatible Timer	RTE-B
Hold-Down Spring	SR3B-02F1 (relays)
Hold-Down Clip	SFA-202 (relays and timers)

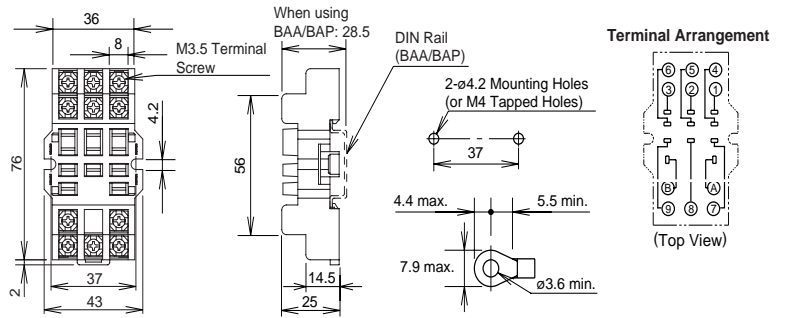

All dimensions are in mm.



1. For socket mounting accessories, see page F-29.
2. For hold-down clip/spring selections, see page F-4.

SH Series: DIN Rail Snap-Mount Sockets

SH1B Sockets



SH1B-05	
Style	5-blade, snap-mount/surface mount
Terminal/Torque	(Coil) M3 screws/(5.5 - 9 in•lbs) (contact) M3.5 screws (9 - 11.5 in•lbs) with captive wire clamp
Wire Size	Maximum up to 2-#12AWG
Electrical Rating	250V, 10A
Compatible Relay	RH1B
Hold-Down Spring	SY2S-02F1
Hold-Down Clip	SFA-101 (top notch), SFA-202 (side notch)

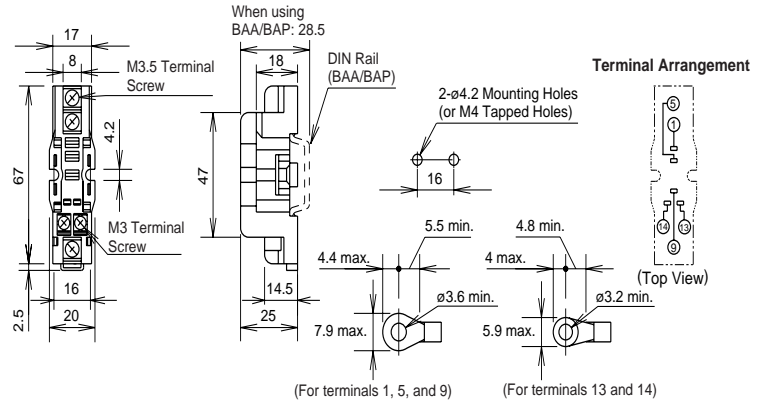

SH1B-05C Fingersafe	
Style	5-blade, snap-mount/surface mount
Terminal/Torque	(Coil) M3 screws/(5.5 - 9 in•lbs) (contact) M3.5 screws with captive wire clamp, fingersafe (9 - 11.5 in•lbs)
Wire Size	Maximum up to 2-#12AWG
Electrical Rating	250V, 10A
Compatible Relay	RH1B
Hold-Down Spring	SY2S-02F1
Hold-Down Clip	SFA-101 (top notch), SFA-202 (side notch)

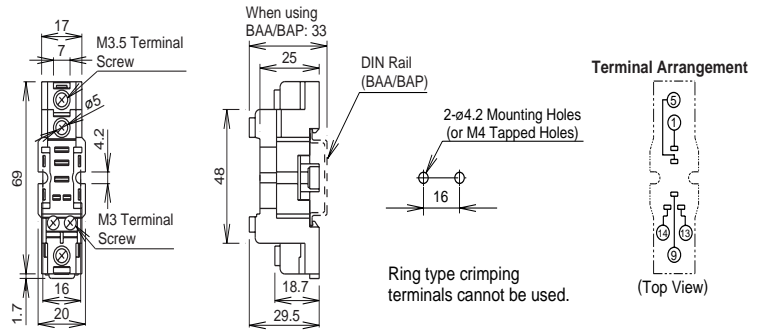

- 1. For socket mounting accessories, see page F-29.
- 2. For hold-down clip/spring selections, see page F-4.

All dimensions are in mm.

SH2B Sockets



SH2B-05

Style	8-blade, snap-mount/surface mount
Terminal/Torque	M3.5 screws with captive wire clamp (9 - 11.5 in•lbs)
Wire Size	Maximum up to 2-#12AWG
Electrical Rating	300V, 10A
Compatible Relay	RH2B
Hold-Down Spring	SY4S-02F1
Hold-Down Clip	SFA-101 (top notch), SFA-202 (side notch)

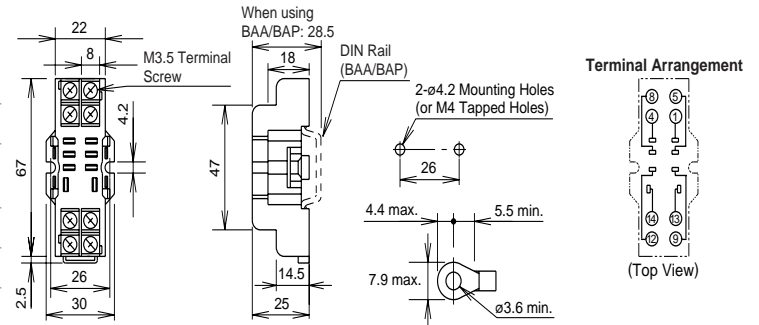

SH2B-05C Fingersafe

Style	8-blade, snap-mount/surface mount
Terminal/Torque	M3.5 screws with captive wire clamp, finger-safe (9 - 11.5 in•lbs)
Wire Size	Maximum up to 2-#12AWG
Electrical Rating	300V, 10A
Compatible Relay	RH2B
Hold-Down Spring	SY4S-02F1
Hold-Down Clip	SFA-101 (top notch), SFA-202 (side notch)

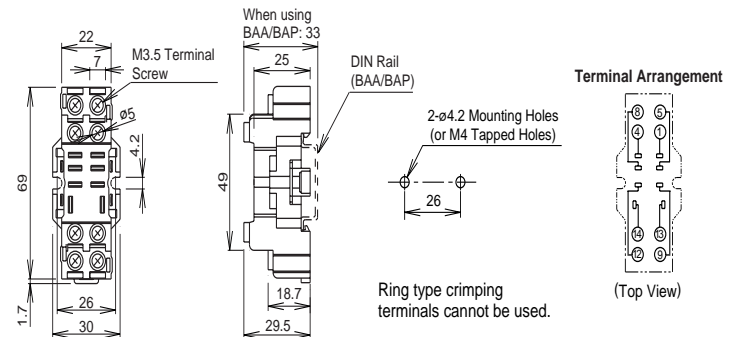

1. For socket mounting accessories, see page F-29.
2. For hold-down clip/spring selections, see page F-4.

All dimensions are in mm.

SH3B Sockets



SH3B-05

Style	11-blade, snap-mount/surface mount
Terminal/Torque	M3.5 screws with captive wire clamp (9 - 11.5 in •lbs)
Wire Size	Maximum up to 2-#12AWG
Electrical Rating	300V, 10A
Compatible Relay	RH3B, RH2LB
Hold-Down Spring	SH3B-05F1
Hold-Down Clip	SFA-101 (top notch), SFA-202 (side notch)

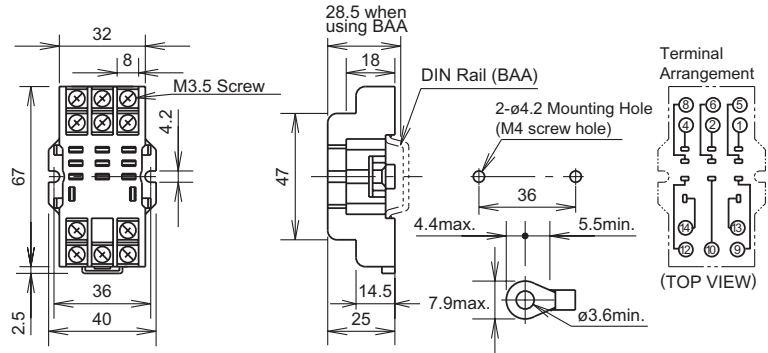

F

Sockets



SH3B-05C Fingersafe

Style	11-blade, snap-mount/surface mount
Terminal/Torque	M3.5 screws with captive wire clamp, fingersafe (9 - 11.5 in •lbs)
Wire Size	Maximum up to 2-#12AWG
Electrical Rating	300V, 10A
Compatible Relay	RH3B, RH2LB
Hold-Down Spring	SH3B-05F1
Hold-Down Clip	SFA-101 (top notch), SFA-202 (side notch)

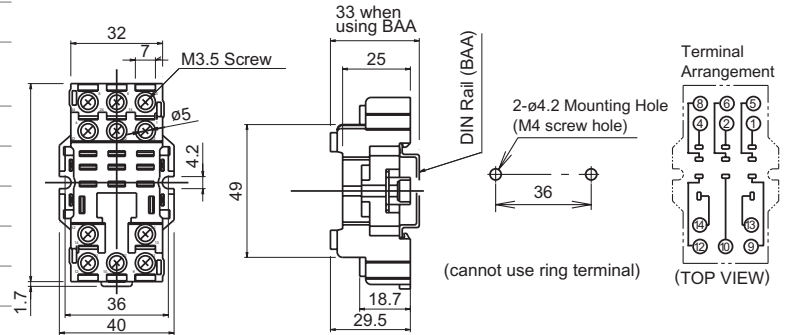

1. For socket mounting accessories, see page F-29.
2. For hold-down clip/spring selections, see page F-4.

All dimensions are in mm.

SH4B Sockets



SH4B-05

Style	14-blade, snap-mount/surface mount
Terminal/Torque	M3.5 screws with captive wire clamp (9 - 11.5 in •lbs)
Wire Size	Maximum up to 2-#12AWG
Electrical Rating	300V, 10A
Compatible Relay	RH4B
Hold-Down Spring	SH4B-02F1
Hold-Down Clip	SFA-101 (top notch), SFA-202 (side notch)

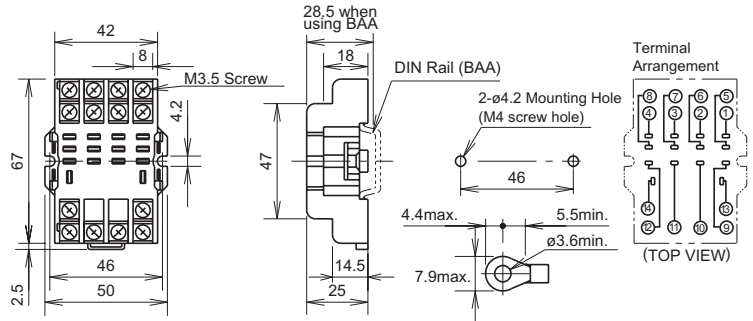

SH4B-05C Fingersafe

Style	14-blade, snap-mount/surface mount
Terminal/Torque	M3.5 screws with captive wire clamp, fingersafe (9 - 11.5 in •lbs)
Wire Size	Maximum up to 2-#12AWG
Electrical Rating	300V, 10A
Compatible Relay	RH4B
Hold-Down Spring	SH4B-02F1
Hold-Down Clip	SFA-101 (top notch), SFA-202 (side notch)

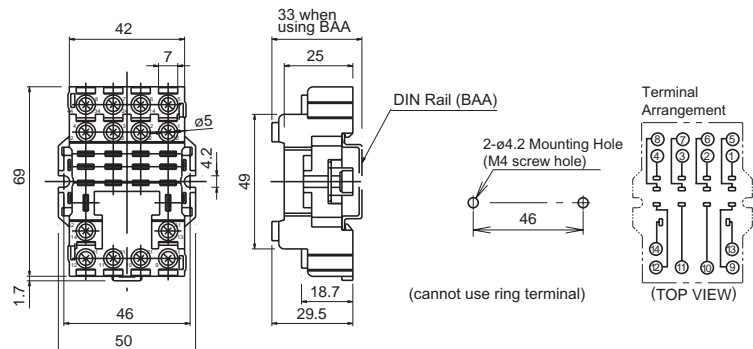

1. For socket mounting accessories, see page F-29.
2. For hold-down clip/spring selections, see page F-4.

All dimensions are in mm.

SY Series: DIN Rail Snap-Mount Sockets

SY2S Sockets



SY2S-05	
Style	8-blade, snap-mount/surface mount
Terminal/Torque	M3 screws with captive wire clamp (5.5 - 9 in •lbs)
Wire Size	Maximum up to 2-#14AWG
Electrical Rating	300V, 7A
Compatible Relay	RY2S, RY22S
Hold-Down Spring	SY2S-02F1
Hold-Down Clip	SFA-101 (top notch), SFA-202 (side notch)

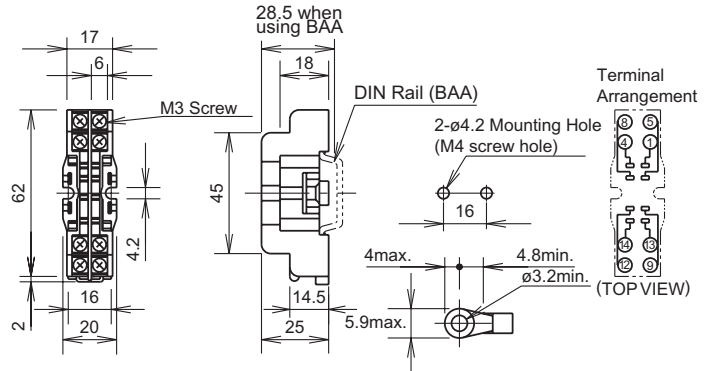

F

Sockets



SY2S-05C Fingersafe	
Style	8-blade, snap-mount/surface mount
Terminal/Torque	M3 screws with captive wire clamp, fingersafe (5.5 - 9 in •lbs)
Wire Size	Maximum up to 2-#14AWG
Electrical Rating	300V, 7A
Compatible Relay	RY2S, RY22S
Hold-Down Spring	SY2S-02F1
Hold-Down Clip	SFA-101 (top notch), SFA-202 (side notch)

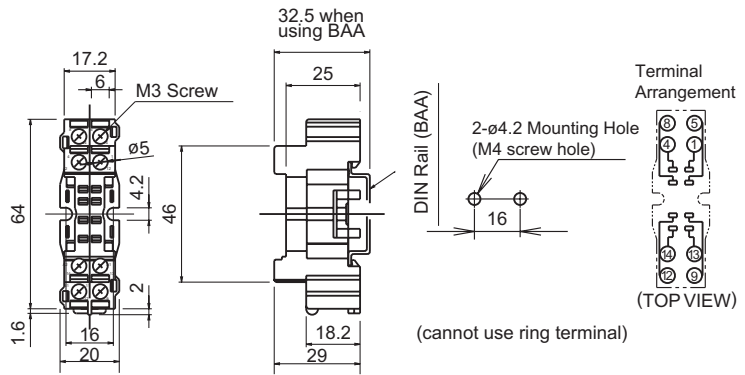

1. For socket mounting accessories, see page F-29.
2. For hold-down clip/spring selections, see page F-4.

All dimensions are in mm.

SY4S Sockets



SY4S-05

Style	14-blade, snap-mount/surface mount
Terminal/Torque	M3 screw with captive wire clamp (5.5 - 9 in•lbs)
Wire Size	Maximum up to 2-#14AWG
Electrical Rating	300V, 7A
Compatible Relay	RY4S, RY42S, RU4S, RU42S, RM2S, *RY2KS, (*latching relay)
Compatible Timer	GT5Y
Hold-Down Spring	SY4S-51F1 for all relays; SY4S-51F3 for RY2KS only
Hold-Down Clip	SFA-101 (top notch), SFA-202 (side notch) for all relays and timers

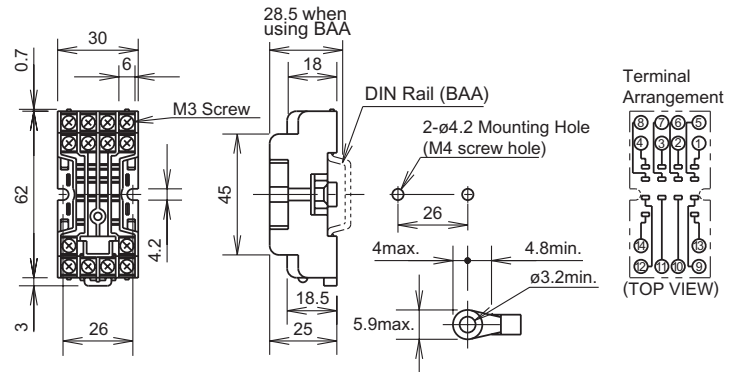

SY4S-05C Fingersafe

Style	14-blade, snap-mount/surface mount
Terminal/Torque	M3 screw with captive wire clamp, fingersafe (5.5 - 9 in•lbs)
Wire Size	Maximum up to 2-#14AWG
Electrical Rating	300V, 7A
Compatible Relay	RY4S, RY42S, RM2S, RU4S, RU42S, *RY2KS, (*latching relay)
Compatible Timer	GT5Y
Hold-Down Spring	SY4S-51F1 for all relays; SY4S-51F3 for RY2KS only
Hold-Down Clip	SFA-101 (top notch), SFA-202 (side notch) for GT5Y timer and relays

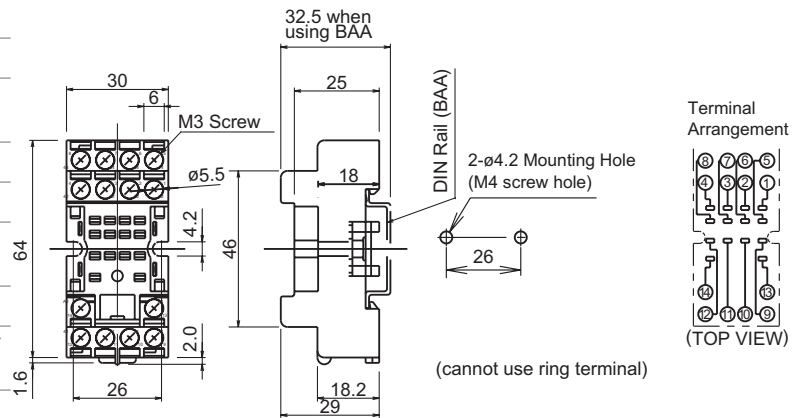

All dimensions are in mm.



1. For socket mounting accessories, see page F-29.
2. For hold-down clip/spring selections, see page F-4.

SM2S Sockets



SM2S-05

Style	8-blade, snap-mount/surface mount
Terminal/Torque	M3 screw with captive wire clamp (5.5 - 9 in •lbs)
Wire Size	Maximum up to 2-#14AWG
Electrical Rating	300V, 10A
Compatible Relay	RU2S, RM2S
Compatible Timer	—
Hold-Down Spring	SY4S-51F1
Hold-Down Clip	SFA-101 (top notch), SFA-202 (side notch)

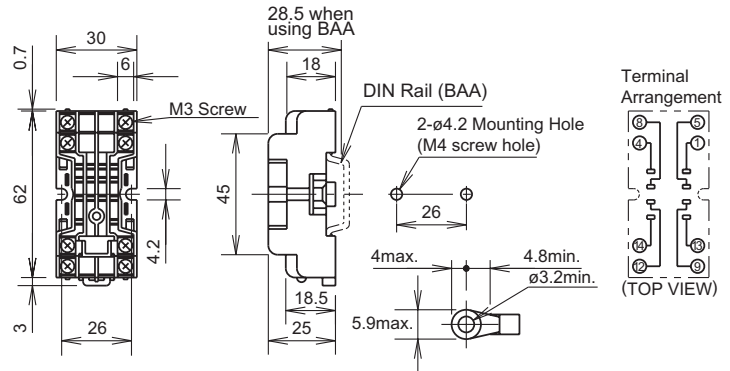

F

Sockets



SM2S-05C Fingersafe

Style	8-blade, snap-mount/surface mount
Terminal/Torque	M3 screw with captive wire clamp, fingersafe (5.5 - 9 in •lbs)
Wire Size	Maximum up to 2-#14AWG
Electrical Rating	300V, 10A
Compatible Relay	RU2S, RM2S
Compatible Timer	—
Hold-Down Spring	SY4S-51F1
Hold-Down Clip	SFA-101 (top notch), SFA-202 (side notch)

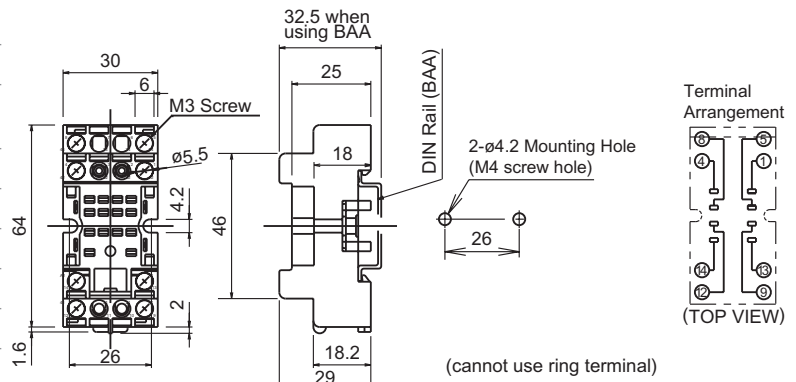

All dimensions are in mm.



1. For socket mounting accessories, see page F-29.
2. For hold-down clip/spring selections, see page F-4.

Accessories

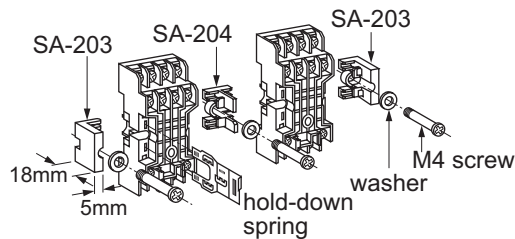

Description	Appearance	Use with	Part No.	Remarks
Aluminum DIN Rail (1 meter length)		All DIN rail sockets	BNDN1000	IDEC offers a low-profile DIN rail (BNDN1000). The BNDN1000 is designed to accommodate snap-mount sockets. Made of durable extruded aluminum, the BNDN-1000 measures 0.413 in height and 1.37 (35mm) in width (DIN standard). Standard length is 39" (1,000mm).
DIN Rail End Stop		DIN rail	BNL5	9.1 mm wide.
Surface Mount End Connector		SY2S, SY4S, SR3B, SH1B, SH2B, SH3B, SH4B	SA-203	For use on ends of socket groupings when surface mounting.
			SA-204	For use between adjoining sockets when surface mounting.
Surface Mount Connector		SY2S, SY4S, SR3B, SH1B, SH2B, SH3B, SH4B	SA-405	For use between adjoining sockets when surface mounting.
DIN Rail Spacer		All DIN rail sockets	SA-406	
Steel Mounting Plates (for panel mount sockets)		SY4S-51, SH2B-51	SA-402	11.42" length with 10 holes.
		SY4S-51, SH2B-51	SA-403	23.33" length with 21 holes.
Relay Holders		RH2B, RM2S, RY4S, RY42S, RU4S, RU42S	RH-01	For diagram, see next page.
		RY2S, RH1B	RH-03	
Replacement Hold-Down Spring Anchor		Horseshoe clip for all DIN rail sockets except SR*P-05(C)	Y778-011	For use with hold-down springs (bale wire types) or DIN rail mount sockets. 2 pieces included with each socket.
Hold-Down Spring for SR*P-05(C)		Chair clip for SR*P-05(C)	Y703-102	For SR2P-05, SR2P-05C, SR3P-05, SR3P-05C

Instructions

Mounting Snap-Mount Sockets

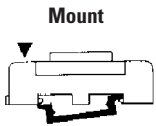

Figure 1

Snap-mount sockets are designed to mount on the BNDN-1000 mounting rail. The built-in mounting clip eliminates mounting hardware and reduces mounting time by 80%.

To mount see Figure 1. Place the end of the socket (end opposite of mounting clip against the outer edge of the rail). Press the socket down firmly until the clip snaps onto the mounting rail. To remove see Figure 2. Pull out the mounting clip with a screwdriver, and lift the socket.

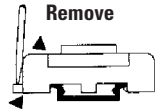
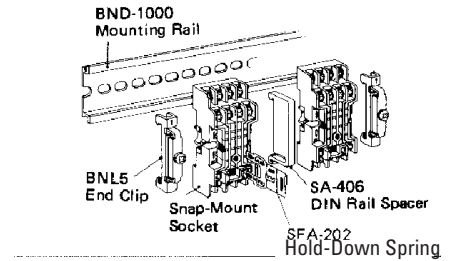

Figure 2

For spacing between adjoining sockets, use the SA-406 DIN rail spacer. Spacers are 0.195" wide. Spacing can be adjusted according to the number of spacers added. Spacers snap on and off easily like snap-mount sockets.

To prevent side-to-side movement, use a BNL-5 end clip at **each** end of every socket row.



Mounting Relay Holders

F
Sockets

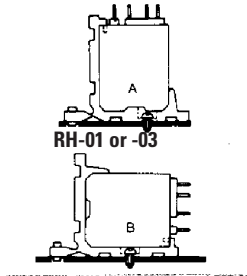

Figure 1

Mount directly onto panel boards in two alternate positions: A and B (see Figure 1).

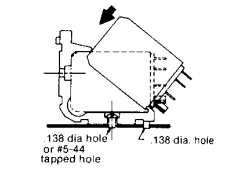

Figure 2

To mount the relay into the holder, hook the bottom edge of the relay case (coil terminal side) onto the relay holder (see Figure 2).

Push down until the relay snaps into place.

Mounting Hold-Down Springs

Take the two anchor clips (horseshoe / U-shaped piece) that come with the socket and insert into the slits on both sides of the socket. Make sure the raised notches on the anchor clip face into the socket.

Plug relay into socket

Insert the open ends of the hold-down spring into either the first or second hole of the anchor clip. The relay-spring combination will determine which hole should be used.

Slide spring over relay.

Dimensions

Surface Mount Sockets (SH2B-02)

IDEC surface mount sockets (SH2B-02) are also designed to mount individually or collectively on a flat surface without the use of a DIN rail. Use the mounting screw between adjoining sockets and at the outer ends of the row of sockets.

Dimension Table

Socket Part No.	Dimension A
SH2B-02	1.14"

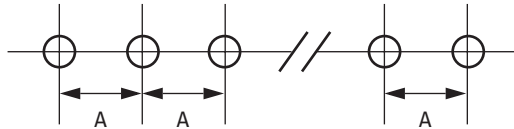

 1. Drawing is not to scale.

Snap-Mount Sockets

Snap-mount sockets are designed to mount individually or collectively without using a rail. Use a SA-405 connector or SA-204 connector between adjoining sockets (see Figures 1 and 2). Use the SA-203 end connector at the outer ends of each socket row when using the SA-204 connector (see Figure 2).

Dimension Table

Socket Part No.	Dim. B	Dim. C	Dim. D
SY2S-05, SY2S-05C	0.669"	0.826"	0.866"
SY4S-05, SY4S-05C	1.024"	1.181"	1.220"
SR3B-05	1.496"	1.693"	1.732"
SH1B-05, SH1B-05C	0.630"	0.787"	0.827"
SH2B-05, SH2B-05C	1.024"	1.181"	1.220"
SH3B-05, SH3B-05C	1.417"	1.575"	1.614"
SH4B-05, SH4B-05C	1.811"	1.969"	2.008"

Using an SA-406 Connector

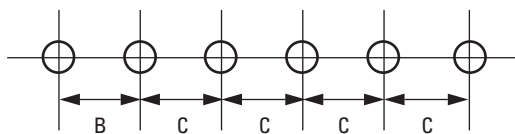

Using SA-203 or SA-204 Connectors

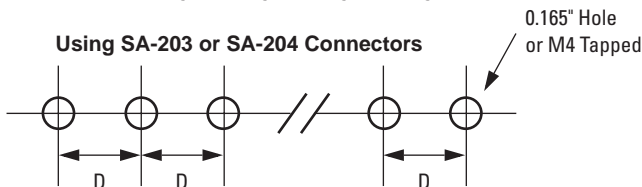

 2. Drawings are not to scale.

Dimensions, continued

Collective Panel Mounting

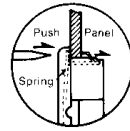
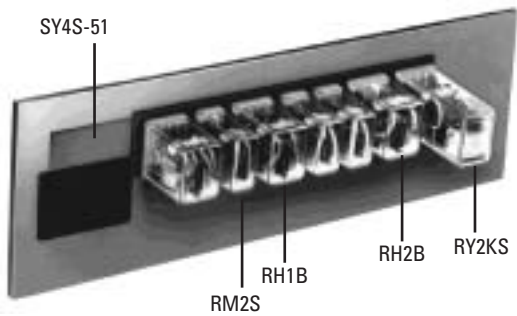

Figure 1

SH and SY series panel mount sockets are designed to mount collectively in panel cut-outs. Insert socket with mounting springs facing the top and bottom edge of the panel cut-out. Push the socket until the mounting spring clips onto the panel. (See Figure 1.)

Dimension Table

Part No.	Width	Relay
SY4S-51	1.063"	RY4S, RY42, RY2KS, RM2S
SH4B-51	1.772"	RH4B
SH3B-51	1.418"	RH3B, RH2LB
SH2B-51	1.063"	RH2B
SH1B-51	0.709"	RH1B
SY2S-51	0.709"	RY2S, RY22S

How to Calculate Cutout Length (L)

Cutout L = A (Total Overall Width of Each Socket) – 0.221" (+ 0", – 0.020")

Example:

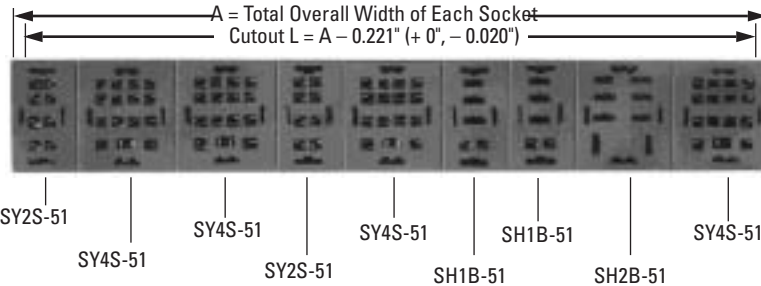

$L = [0.709" + 1.063" + 1.063" + 0.709" + 1.063" + 0.709" + 1.063" + 1.063"] - 0.221" = 7.93"$

$L = 7.93" (+ 0", - 0.020")$

Mounting Plate

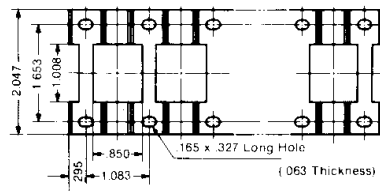

F
Sockets