

MINIATURE RELAY

1 POLE

(HIGH FREQUENCY SIGNAL SWITCHING)

UM1 SERIES

RoHS Compliant

■ FEATURES

- Subminiature polarized relay
- Excellent high frequency characteristics
 - Isolation : min. 60 dB
 - Insertion loss : max. 1 dB
 - V.S.W.R. : max. 1.2
 } at 900 MHz (Impedance of the measuring devices is 75Ω)
- High reliability—Bifurcated contacts
- Wide operating range
- DIL pitch terminals
- Plastic sealed type
- Latching type available
- RoHS compliant since date code: 0437T2
Please see page 7 for more information

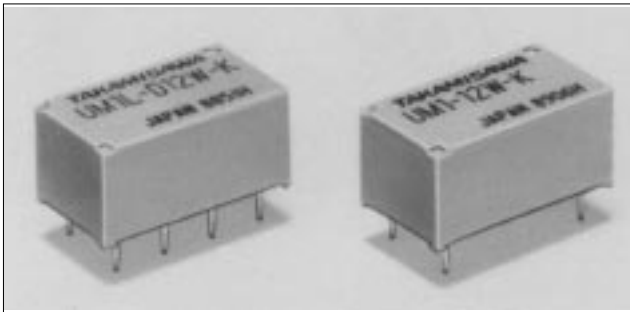

■ ORDERING INFORMATION

[Example] $\frac{UM1}{(a)} \frac{L}{(b)} - \frac{D}{(c)} \frac{12}{(d)} \frac{W}{(e)} - \frac{K}{(f)}$

(a)	Series Name	UM1: UM1 Series
(b)	Operation Function	Nil : Standard type L : Latching type
(c)	Number of Coil	Nil : Single winding type D : Double winding type
(d)	Nominal Voltage	Refer to the COIL DATA CHART
(e)	Contact	W : Bifurcated type
(f)	Enclosure	K : Plastic sealed type

UM1 SERIES

■ SPECIFICATIONS

Item		Standard Type	Single Winding Latching Type	Double Winding Latching Type
		UM1-() W-K	UM1L-() W-K	UM1L-D () W-K
Contact	Arrangement	1 form C (SPDT)		
	Material	Gold clad (stationary contact), gold plate (movable contact)		
	Style	Bifurcated		
	Resistance (initial)	Maximum 100 mΩ		
	Rating (resistive)	10 mA 24 VDC 1 W (at 900 MHz)		
	Maximum Carrying Current	0.5 A		
	Maximum Switching Power	1 W (DC) 10 W (at 900 MHz)		
	Maximum Switching Voltage	30 VDC		
	Maximum Switching Current	100 mA		
	Minimum Switching Load*1	0.01 mA 10 mVDC		
Excellent High Frequency Characteristics	Isolation	Minimum 60 dB(at 900 MHz), impedance of the measuring devices is 75Ω		
	Insertion Loss	Maximum 1 dB(at 900 MHz), impedance of the measuring devices is 75Ω		
	V.S.W.R.	Maximum 1.2(at 900 MHz), impedance of the measuring devices is 75Ω		
Coil	Nominal Power (at 20°C)	0.2 to 0.22 W	0.2 W	0.4 W
	Operate Power (at 20°C)	0.1 to 0.11 W	0.1 W	0.2 W
	Operating Temperature	-30°C to +80°C (no frost)		-30°C to +60°C (no frost)
Time Value	Operate (at nominal voltage)	Maximum 6 ms	Maximum 6 ms (set)	
	Release (at nominal voltage)	Maximum 5 ms	Maximum 6 ms (reset)	
Insulation	Resistance (at 500 VDC)	Minimum 1,000 MΩ		
	Dielectric Strength	between open contacts between contacts and shield terminals	500 VAC 1 minute	
		between coil and contacts, between coil and shield terminals	1,000 VAC 1 minute	
Life	Mechanical	1 × 10 ⁶ operations minimum		
	Electrical	3 × 10 ⁵ operations minimum (at nominal load)		
Other	Vibration	Misoperation	10 to 55 Hz (double amplitude of 3.3 mm)	
		Endurance	10 to 55 Hz (double amplitude of 5.0 mm)	
	Shock	Misoperation	500 m/s ² (11 ±1 ms)	
		Endurance	1,000 m/s ² (6 ±1 ms)	
	Weight	Approximately 4 g		

*1 Minimum switching loads mentioned above are reference values. Please perform the confirmation test with the actual load before production since reference values may vary according to switching frequencies, environmental conditions and expected reliability levels.

UM1 SERIES

■ COIL DATA CHART

MODEL		Nominal voltage	Coil resistance (±10%)	Must operate voltage*1	Must release voltage*1	Nominal power
Standard Type	UM1- 1.5 W-K	1.5 VDC	11.2Ω	+1.05 VDC	+0.08 VDC	200 mW
	UM1- 3 W-K	3 VDC	45 Ω	+2.1 VDC	+0.15 VDC	200 mW
	UM1- 4.5 W-K	4.5 VDC	101 Ω	+3.15 VDC	+0.23 VDC	200 mW
	UM1- 5 W-K	5 VDC	125 Ω	+3.5 VDC	+0.25 VDC	200 mW
	UM1- 6 W-K	6 VDC	180 Ω	+4.2 VDC	+0.3 VDC	200 mW
	UM1- 9 W-K	9 VDC	405 Ω	+6.3 VDC	+0.45 VDC	200 mW
	UM1- 12 W-K	12 VDC	720 Ω	+8.4 VDC	+0.6 VDC	200 mW
	UM1- 18 W-K	18 VDC	1,620 Ω	+12.6 VDC	+0.9 VDC	200 mW
	UM1- 24 W-K	24 VDC	2,880 Ω	+16.8 VDC	+1.2 VDC	200 mW
	UM1- 48 W-K	48 VDC	10,472 Ω	+33.6 VDC	+2.4 VDC	220 mW

Note: *1 Specified values are subject to pulse wave voltage.
All values in the table are measured at 20°C.

UM1 SERIES

MODEL		Nominal voltage	Coil resistance ($\pm 10\%$)	Set voltage*1	Reset voltage*1	Nominal power
Single Winding Latching Type	UM1L- 1.5 W-K	1.5 VDC	11.2 Ω	+1.05 VDC	-1.05 VDC	200 mW
	UM1L- 3 W-K	3 VDC	45 Ω	+2.1 VDC	-2.1 VDC	200 mW
	UM1L- 4.5 W-K	4.5 VDC	101 Ω	+3.15 VDC	-3.15 VDC	200 mW
	UM1L- 5 W-K	5 VDC	125 Ω	+3.5 VDC	-3.5 VDC	200 mW
	UM1L- 6 W-K	6 VDC	180 Ω	+4.2 VDC	-4.2 VDC	200 mW
	UM1L- 9 W-K	9 VDC	405 Ω	+6.3 VDC	-6.3 VDC	200 mW
	UM1L- 12 W-K	12 VDC	720 Ω	+8.4 VDC	-8.4 VDC	200 mW
	UM1L- 18 W-K	18 VDC	1,620 Ω	+12.6 VDC	-12.6 VDC	200 mW
	UM1L- 24 W-K	24 VDC	2,880 Ω	+16.8 VDC	-16.8 VDC	200 mW
	UM1L- 48 W-K	48 VDC	11,520 Ω	+33.6 VDC	-33.6 VDC	200 mW
Double Winding Latching Type	UM1L-D1.5 W-K	1.5 VDC	P 5.6 Ω	+1.05 VDC		400 mW
			S 5.6 Ω		+1.05 VDC	
	UM1L-D 3 W-K	3 VDC	P 22.5 Ω	+2.1 VDC		400 mW
			S 22.5 Ω		+2.1 VDC	
	UM1L-D4.5 W-K	4.5 VDC	P 50.6 Ω	+3.15 VDC		400 mW
			S 50.6 Ω		+3.15 VDC	
	UM1L-D 5 W-K	5 VDC	P 62.5 Ω	+3.5 VDC		400 mW
			S 62.5 Ω		+3.5 VDC	
	UM1L-D 6 W-K	6 VDC	P 90 Ω	+4.2 VDC		400 mW
			S 90 Ω		+4.2 VDC	
	UM1L-D 9 W-K	9 VDC	P 202.5 Ω	+6.3 VDC		400 mW
			S 202.5 Ω		+6.3 VDC	
	UM1L-D 12 W-K	12 VDC	P 360 Ω	+8.4 VDC		400 mW
			S 360 Ω		+8.4 VDC	
	UM1L-D 18 W-K	18 VDC	P 810 Ω	+12.6 VDC		400 mW
			S 810 Ω		+12.6 VDC	
	UM1L-D 24 W-K	24 VDC	P 1,440 Ω	+16.8 VDC		400 mW
			S 1,440 Ω		+16.8 VDC	
UM1L-D 48 W-K	48 VDC	P 5,760 Ω	+33.6 VDC		400 mW	
		S 5,760 Ω		+33.6 VDC		

Note: *1 Specified values are subject to pulse wave voltage.
All values in the table are measured at 20°C.

P: Primary coil S: Secondary coil

CHARACTERISTIC DATA

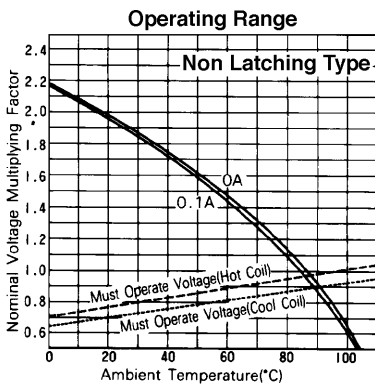
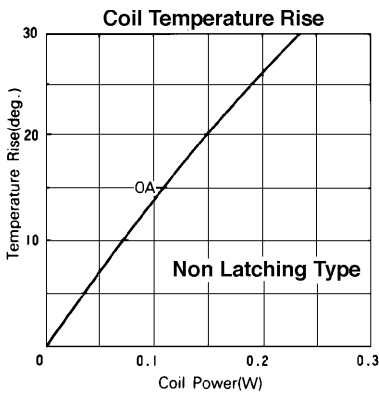
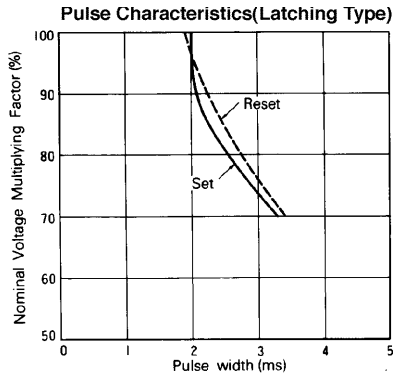
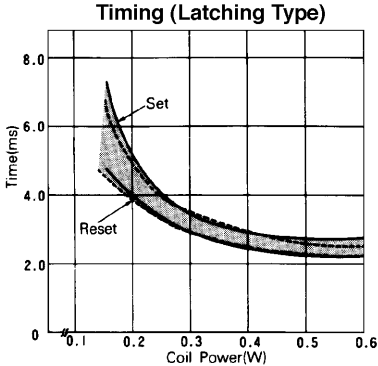
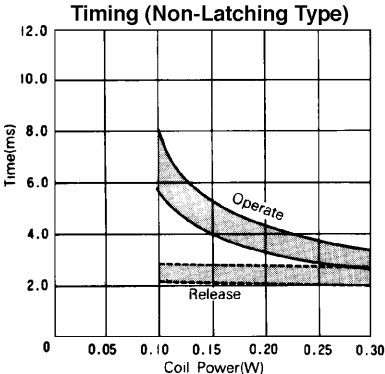

REFERENCE DATA

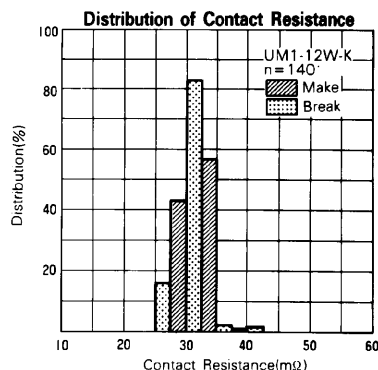
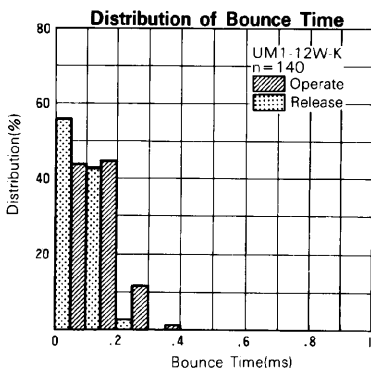
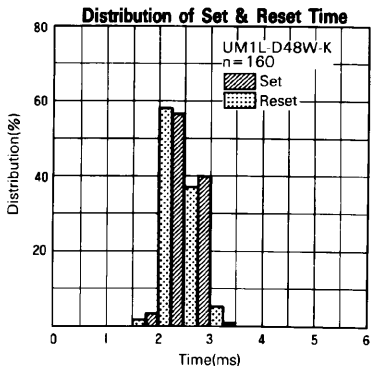
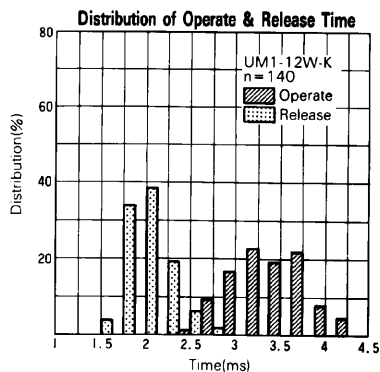
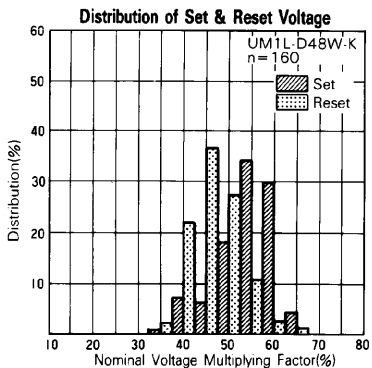
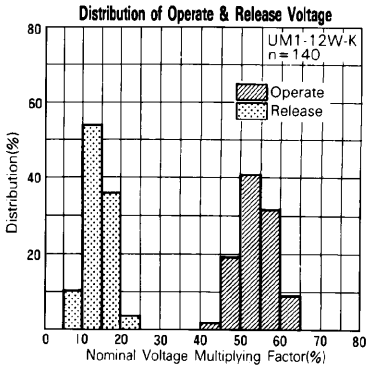

UM1 SERIES

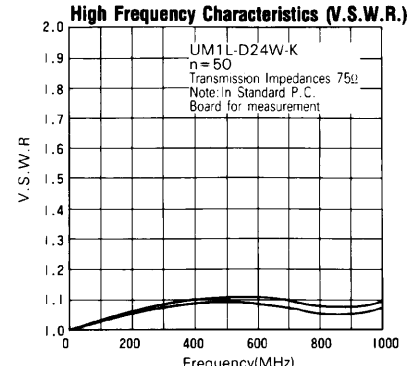
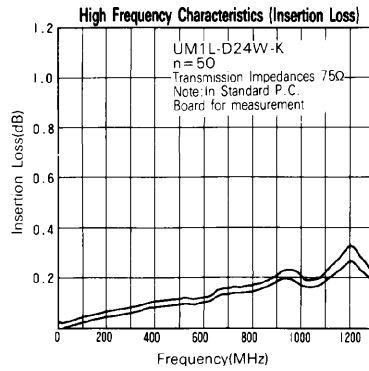
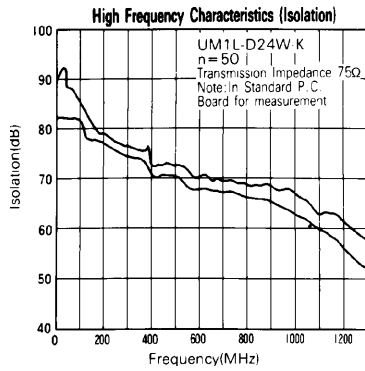
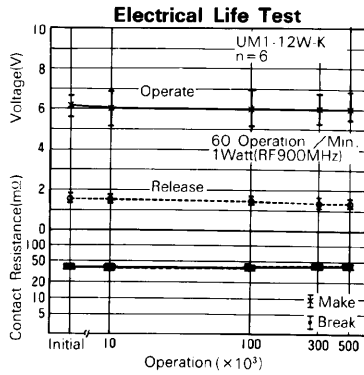
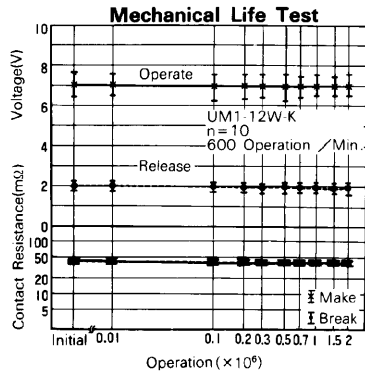

■ DIMENSIONS

● Dimensions

● Schematics

(Bottom view)

● PC board mounting

hole layout

(Bottom view)

UM1, UM1L type (Non-latching type, single winding latching type)

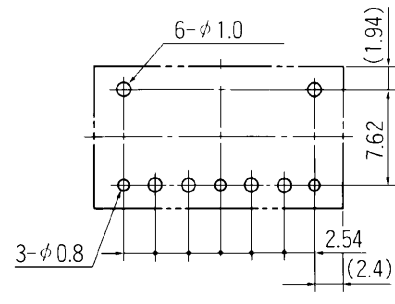
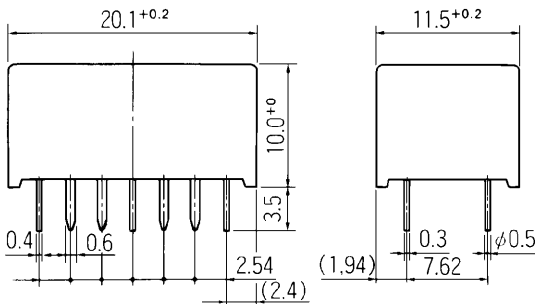

UM1L-D type (Double winding latching type)

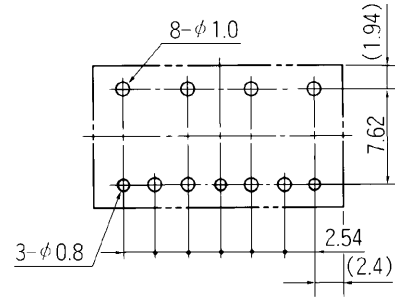
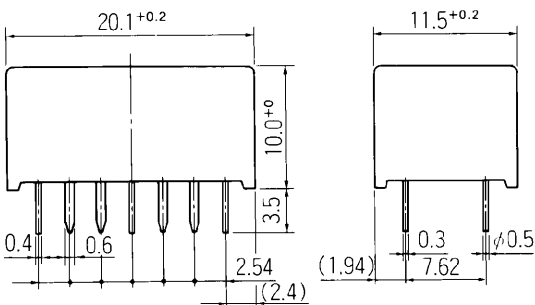

Unit: mm

RoHS Compliance and Lead Free Relay Information

1. General Information

- Relays produced after the specific date code that is indicated on each data sheet are lead-free now. Most of our signal and power relays are lead-free. Please refer to Lead-Free Status Info. (<http://www.fc.ai.fujitsu.com/pdf/LeadFreeLetter.pdf>)
- Lead free solder paste currently used in relays is Sn-3.0Ag-0.5Cu. From February 2005 forward Sn-3.0Cu-Ni will be used for FTRB3 and FTR-B4 series relays.
- Most signal and some power relays also comply with RoHS. Please refer to individual data sheets. Relays that are RoHS compliant do not contain the 6 hazardous materials that are restricted by RoHS directive (lead, mercury, cadmium, chromium IV, PBB, PBDE).
- It has been verified that using lead-free relays in lead assembly process will not cause any problems (compatible).
- "LF" is marked on each outer and inner carton. (No marking on individual relays).
- To avoid lead relays (for lead-free sample, etc.) please consult with area sales office. We will ship lead relays as long as the lead relay inventory exists.

2. Recommended Lead Free Solder Profile

- Recommended solder paste Sn-3.0Ag-0.5Cu and Sn-3.0 Cu-Ni (only FTR-B3 and FTR-B4 from February 2005)

Reflow Solder condition

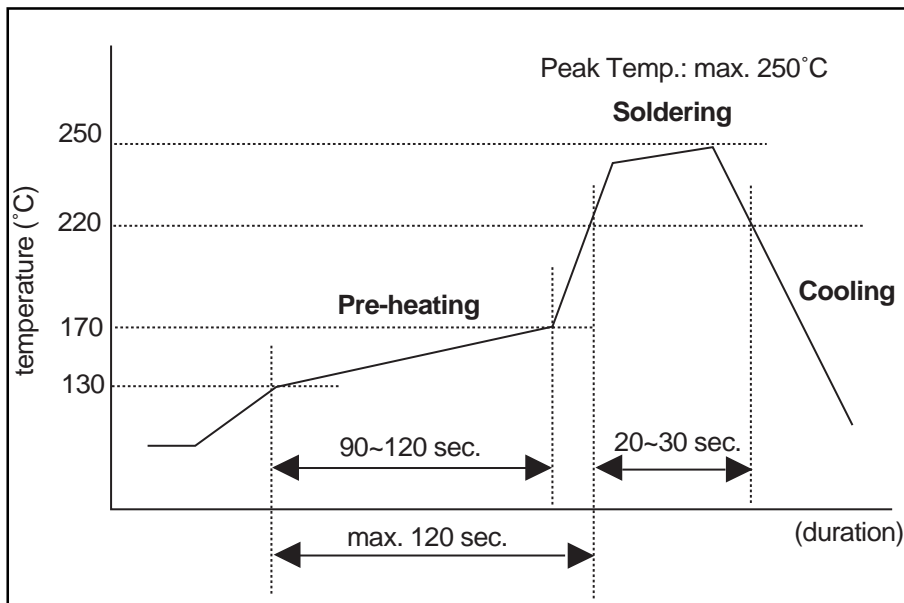

Flow Solder condition:

Pre-heating: maximum 120°C
Soldering: dip within 5 sec. at 260°C solder bath

Solder by Soldering Iron:

Soldering Iron
Temperature: maximum 360°C
Duration: maximum 3 sec.

We highly recommend that you confirm your actual solder conditions

3. Moisture Sensitivity

- Moisture Sensitivity Level standard is not applicable to electromechanical relays.

4. Tin Whisker

- SnAgCu solder is known as low risk of tin whisker. No considerable length whisker was found by our in-house test.

5. Solid State Relays

- Each lead terminal will be changed from solder plating to Sn plating and Nickel plating. A layer of Nickel plating is between the terminal and the Sn plating to avoid whisker.

Fujitsu Components International Headquarter Offices

Japan

Fujitsu Component Limited
Gotanda-Chuo Building
3-5, Higashigotanda 2-chome, Shinagawa-ku
Tokyo 141, Japan
Tel: (81-3) 5449-7010
Fax: (81-3) 5449-2626
Email: promothq@ft.ed.fujitsu.com
Web: www.fcl.fujitsu.com

North and South America

Fujitsu Components America, Inc.
250 E. Caribbean Drive
Sunnyvale, CA 94089 U.S.A.
Tel: (1-408) 745-4900
Fax: (1-408) 745-4970
Email: marcom@fcai.fujitsu.com
Web: www.fcai.fujitsu.com

Europe

Fujitsu Components Europe B.V.
Diamantlaan 25
2132 WV Hoofddorp
Netherlands
Tel: (31-23) 5560910
Fax: (31-23) 5560950
Email: info@fceu.fujitsu.com
Web: www.fceu.fujitsu.com

Asia Pacific

Fujitsu Components Asia Ltd.
102E Pasir Panjang Road
#04-01 Citilink Warehouse Complex
Singapore 118529
Tel: (65) 6375-8560
Fax: (65) 6273-3021
Email: fcal@fcal.fujitsu.com
www.fcal.fujitsu.com

© 2004 Fujitsu Components America, Inc. All company and product names are trademarks or registered trademarks of their respective owners. Rev. 12/07/2004.